

B2900B/B2900BL Series Precision Source/Measure Unit



Table of Contents

- Get Rapid and Accurate Measurement Results..... 3
- The Best SMU Solution for a Broad Range of IV Measurements..... 4
- Integrated Source and Measurement Capabilities Simplify Difficult IV Measurement Tasks..... 6
- Fast Throughput Lowers Cost-of-Test..... 10
- Overview: Why Use an SMU? 11
- Innovative GUI and 4.3" Color LCD Display Facilitate Fast Bench-top Test, Debug and Characterization13
- Multiple Remote Control Choices Optimize Performance for Different Applications 15
- BenchVue..... 15
- Graphical Web Interface 16
- EasyEXPERTgroup+ 17
- Available Accessories Facilitate Special Test Needs 17
- Specifications 19
- Furnished Accessories..... 31
- Ordering Information 31

Get Rapid and Accurate Measurement Results

The Keysight B2900B/BL Series Precision Source/Measure Units are compact and cost-effective bench-top Source/Measure Units (SMUs) with the capability to source and measure both voltage and current. These capabilities make the B2900B/BL Series SMU ideal for a wide variety of IV (current versus voltage) measurement tasks that require both high resolution and accuracy.

The B2900B/BL Series SMU has a voltage maximum of ± 210 V, a current maximum ± 3 A DC, and ± 10.5 A pulsed sourcing capabilities. With a precision minimum of 10 fA/100 nV sourcing and measuring resolution, a color LCD graphical user interface (GUI) and several task-based viewing modes will improve your productivity for test, debug, and characterization.

The B2900B/BL Series SMU offers superior measurement throughput and supports conventional SMU SCPI commands for easy test code migration. These features improve efficiency and lower the cost of ownership when integrating the SMUs into systems for production test.

The B2900B/BL Series SMU consists of six models — the B2901BL, B2910BL, B2901B, B2902B, B2911B, and B2912B. The differentiation between the models is according to their available features: output range, number of digits displayed, measurement resolution, minimum timing interval, viewing modes, and SMU channels. These model choices make it easy for selecting the performance and price you need for your testing requirements.

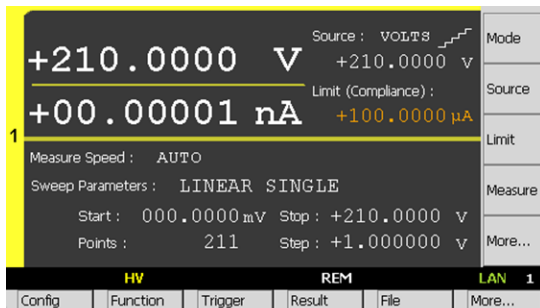

Single View

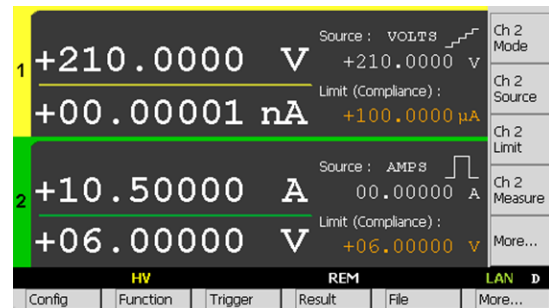

Dual View

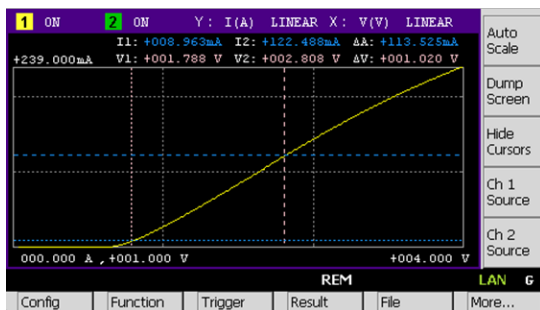

Graph View

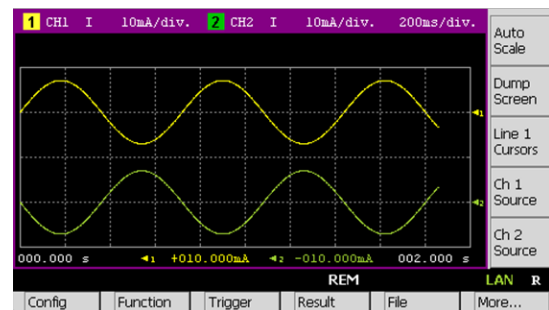

Roll View

Feature	Benefit
Integrated 4-quadrant sourcing and measuring capabilities	Easily and accurately measure current and voltage using a single instrument without the need to manually change any connections
Measurement range: ± 210 V, ± 3 A (DC), ± 10.5 A (pulsed)	A single SMU product covers both high voltage and high current measurement needs, allowing for more standardization and simplifying inventory and support concerns.
Source and measurement resolution down to 10 fA and 100 nV	Can make low-level measurements using a low-cost bench-top SMU that were previously only possible using a more expensive semiconductor device analyzer.
User-friendly front panel GUI with 4.3 inch color LCD display supports both graphical and numerical view modes	Can quickly and easily perform measurements and display data on the front panel, thereby greatly speeding up interactive test, characterization and debug operations.
10 microsecond digitizing capability	Can capture low frequency phenomena in addition to DC characteristics
PC-based control software	Can make measurements remotely from a PC without the need to program.
Supports both conventional and default SCPI commands	Conventional SCPI commands provide some compatibility with older SMU code (such as Keithley 2400 series) to minimize code conversion work. Default SCPI commands support advanced B2900B/BL Series features
Small form factor with USB2.0, LAN, GPIB and digital I/O interfaces	Easy integration into rack and stack systems.

The Best SMU Solution for a Broad Range of IV Measurements

SMUs are popular and widespread instruments for performing IV measurements in many different fields and applications due to their integrated voltage and current sourcing and measurement capabilities. The B2900B/BL Series SMU provides superior performance and usability at a very reasonable price. In addition, the B2900B/BL Series SMU supports many functions to speed up production test and increase throughput. The versatile measurement capabilities of the B2900B/BL Series SMU make it an ideal choice for a variety of IV measurements such as semiconductor test, active/passive component test and general electronic device and material characterization.

The B2900B/BL Series SMU has a broad application range that spans uses from R&D and education to industrial development, production test and automated manufacturing. Moreover, they work equally well as either standalone or system components.

Testing semiconductors, discrete and passive components

- Diodes, laser diodes, LEDs
- Photodetectors, sensors
- Field effect transistors (FETs), bipolar junction transistors (BJTs)
- ICs (analog ICs, RFICs, MMICs, etc)
- Resistor, varistor, thermistors, switches

Testing precision electronics and green energy devices

- Photovoltaic cells
- Power transistors, power devices
- Battery
- Automotive
- Medical instruments
- Power and DC bias source for circuit test

Research and education

- New material investigations
- Nano devices characterization (e.g. CNT)
- Giant magnetic resistance (GMR)
- Organic devices
- Any precise voltage/current source and measurement

Application literature is available on the Keysight web site. For more information, please visit www.keysight.com/find/precisionSMU



Integrated Source and Measurement Capabilities Simplify Difficult IV Measurement Tasks

The B2900B/BL Series SMU reduces measurement complexity

Performing IV measurements with conventional instruments such as voltage/current sources, arbitrary waveform generators (AWGs), switches, and voltage/current meters is complicated and confusing. It requires deep technical knowledge of both the measurement technique and the instrumentation to perform an accurate measurement.

The B2900B/BL Series SMU integrates many different source and measurement capabilities into one compact form factor. It can operate as a seamless 4-quadrant precision voltage/current source, an electrical load, an accurate voltage/current meter, a pulse generator and an AWG. Its versatile all-in-one integrated source and measurement capabilities allow it to perform a wide variety of measurements from DC to low frequency AC without the need to change connections or use additional equipment. Moreover, the availability of 2-channel models supports the testing of devices with up to three terminals (as long as one terminal can be tied to the circuit common).

If you wish to learn more about the advantages of using SMUs to make IV measurements, then please refer to the section at the back of this datasheet entitled “Overview: Why use an SMU?”

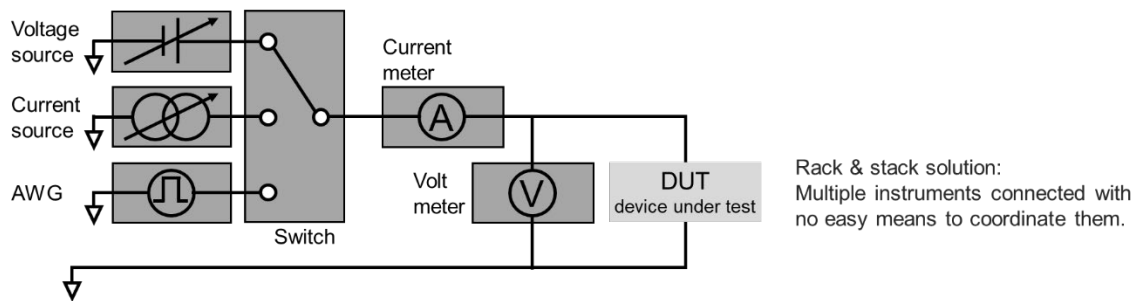

Same measurement using an SMU

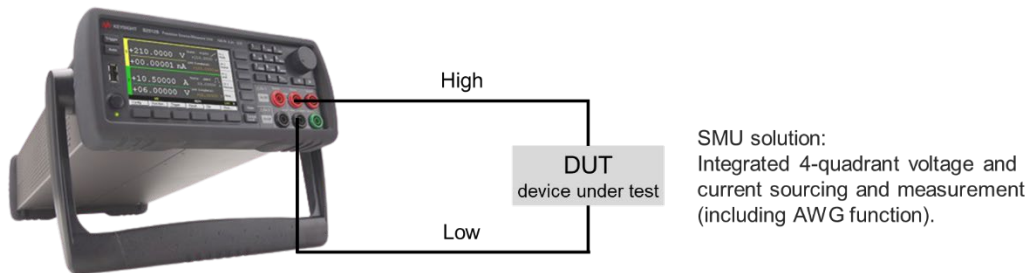

Wide Voltage and Current Coverage for Testing a Variety of Devices

Test up to 210 V and 3 A (DC) or 10.5 A (pulsed) with a single instrument

The B2900B SMUs can source and measure ± 210 V and currents of ± 3 A DC, or ± 10.5 A pulsed. This performance versatility enables you to standardize on a single SMU model, which minimizes support costs. These capabilities are present on both single- and dual-channel versions. Both channels in the 2-channel version operate independently.

Integrated sweep and arbitrary waveform measurement functionality

The B2900B/BL Series SMU has capabilities that allow it to perform more than just simple DC and pulsed measurements. The B2900B/BL Series SMUs have a built-in sweep capability that supports all of the standard sweep parameters such as linear and logarithmic modes, single and double sweep functions and constant and pulsed sweep operation. The B2900B/BL Series SMU's GUI fully supports the sweep measurement function, thereby allowing sweep measurements to be made and displayed quickly from the instrument front panel. Of course, the user can also make the same sweep measurements just as efficiently on the B2900B/BL Series SMU under remote control using SCPI commands. This integrated sweep measurement capability improves efficiency and reduces measurement setup time.

The B2900B/BL Series SMU has arbitrary waveform generation (AWG) and list sweep capabilities. The AWG and list sweep functions enable you to create waveforms with up to 100,000 steps for maximum flexibility while the B2901BL SMU has up to 10,000 steps. You can specify a waveform of arbitrary shape using familiar spreadsheet compatible data-entry formats. The AWG and list sweep features are especially useful when characterizing devices where the response varies depending on the applied voltage or current. You now have the flexibility to focus on areas of interest.

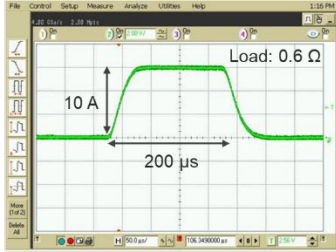

You can create current pulses of up to 10.5 amps, which helps to minimize device self-heating effects.

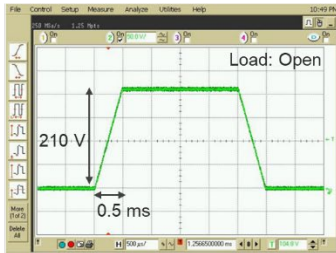

You can ramp up to a voltage of 200 V in 0.5 millisecond, which is useful for evaluating high-power components.

Built-in functions provide flexible waveform generation capabilities

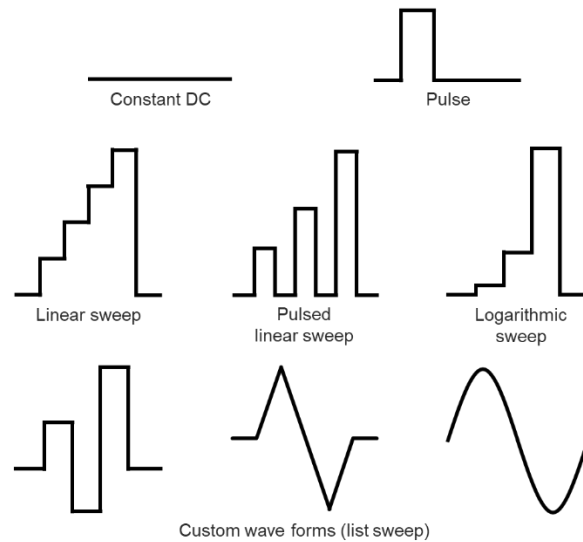

Superior Bench-top SMU Measurement Performance

Source and measurement resolution - 10 fA and 100 nV

The B2900B Series SMU consists of four models — the differentiation is between the number of channels, and measurement and sourcing resolution. The B2901B (single-channel) and B2902B (dual-channel) SMUs have 100 fA and 100 nV measurement resolution, 1 pA, and 1 μV sourcing resolution. The B2911B (single-channel) and B2912B (dual-channel) SMUs have 10 fA and 100 nV both measurement and sourcing resolution.

The B2900BL Series SMU consists of two models. The B2901BL SMU has 1 pA and 100 nV measurement resolution, 10 pA, and 1 μV sourcing resolution. The B2910BL SMU has 10 fA and 100 nV measurement resolution, 100 fA, and 1 μV sourcing resolution.

The B2900B/BL Series SMUs support popular banana jack style inputs for cost-effective and flexible connectivity. For low current measurements below 1 nA, banana jack to triaxial adapters are available.

Capture transient phenomena effortlessly

The B2900B/BL Series SMUs support a high-speed sampling measurement function that permits the capture and display of low-frequency transient phenomena. The B2901BL and B2910BL SMUs support a 200 μs (5,000 points/second) and 50 μs (20,000 points/second) sampling rate. The B2901B and B2902B SMUs support a 20 μs (50,000 points/second) sampling rate, and the B2911B and B2912B SMUs support a 10 μs (100,000 points/second) sampling rate. The maximum achievable sampling rate depends on many factors, including signal level, ambient noise, and desired resolution.

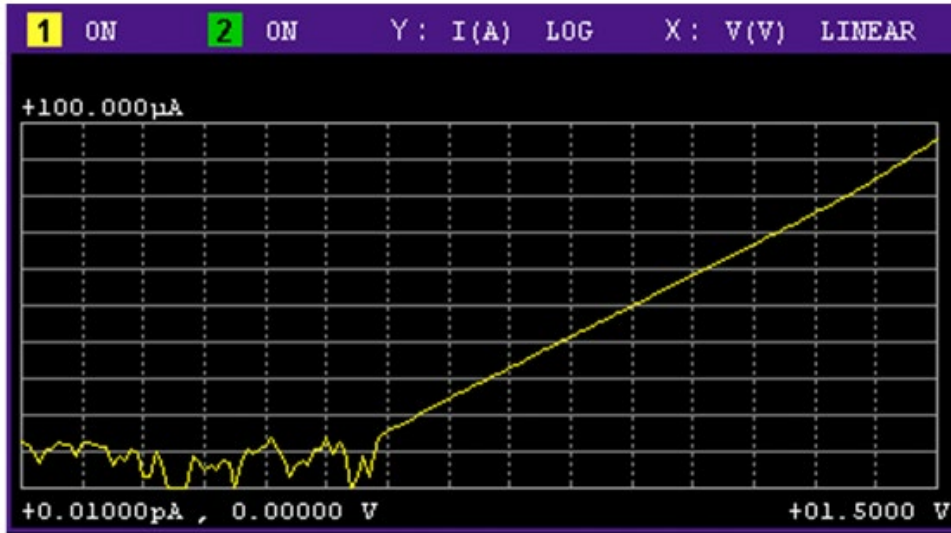

Figure 1. You can make and display accurate low-current measurements directly on the B2900B/BL front panel.

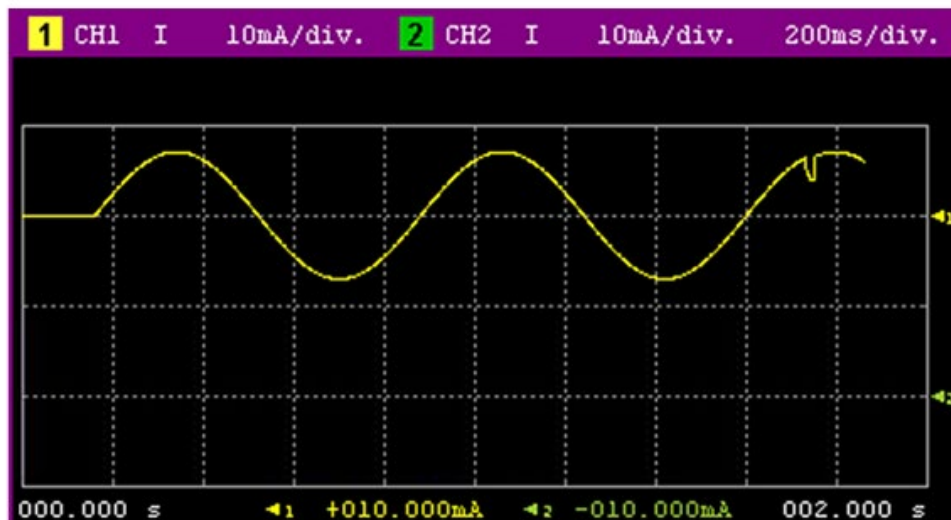

Figure 2. Roll view mode allows you to capture low-frequency transient phenomena.

4-wire measurement capability permits accurate low resistance measurement

When measuring small resistances the innate cable resistance can create serious measurement error. To solve this, the B2900B/BL Series SMU supports a 4-wire (also known as a remote sense or Kelvin connection) measurement function. In the 4-wire scheme two of the connectors force current and the other two connectors measure voltage. Since the connectors measuring voltage do not have any current flowing through them, they can accurately sense the actual voltage at the DUT.

Measure large capacitive loads without oscillation

Large capacitive loads can sometimes cause SMUs to oscillate. To mitigate this, the B2900B/BL Series SMU supports a high capacitance measurement mode. The high capacitance mode enables the measurement of large capacitive loads without having to worry about SMU oscillation.

Fast Throughput Lowers Cost-of-Test

Best-in-class measurement throughput

Although an excellent R&D tool, the B2900B/BL Series SMU is also well-suited for production test. It can achieve excellent accuracy and repeatability at even short integration times. The B2900B/BL Series SMU possesses the fastest measurement speed of any SMU in its class.

Program memory and trace buffer features improve throughput

To reduce bus communication time, the B2900B/BL Series SMUs support a program memory feature that enables you to store long strings of SCPI commands within the instrument. You can execute these code sequences by sending a single command across the communication bus to improve throughput for frequently performed command strings. The B2900B/BL Series SMUs support a trace buffer that can store up to 100,000 data points while the B2901BL stores 10,000 data points. Downloaded results from multiple measurements are available at once to improve overall throughput while reducing the data transfer time.

SCPI commands provide compatibility and versatility

Standard Commands for Programmable Instruments (SCPI) are a popular and easy-to-understand instrument control protocol. The B2900B/BL Series SMU supports two SCPI command sets, conventional and default, to provide both code compatibility and flexibility. The conventional command set has a large number of its commands compatible with those of older SMUs (such as the Keithley 2400) to minimize code conversion work. The default command set supports advanced B2900B/BL Series SMU features and they should be used to fully utilize its performance and capabilities.

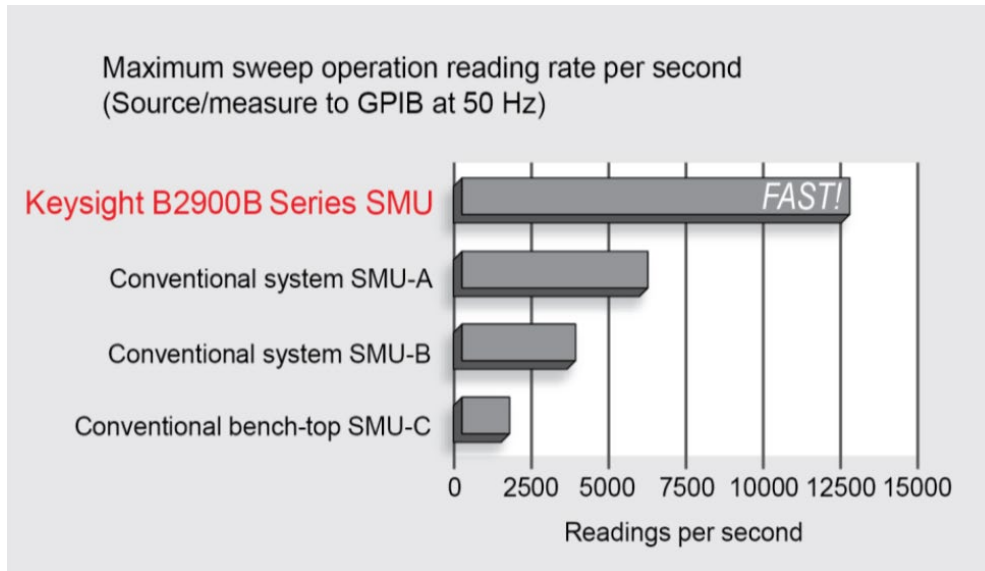

Overview: Why Use an SMU?

Resource integration reduces measurement error

An SMU is an instrument that combines the capabilities of a current source, a voltage source, a current meter and a voltage meter (along with the capability to switch easily between these various functions). Because the source and measurement circuitry are closely integrated, the user can achieve far better measurement performance with less measurement error than would be possible by using various independent instruments to make the same measurement.

Feedback mechanism stabilizes voltage and current sourcing

Since SMUs have the ability to very accurately measure their own current and voltage output, they have many advantages over conventional power supplies. All SMUs have internal feedback loops that provide instantaneous feedback to the sourcing circuitry, which in-turn allows the SMU output to remain accurate and stable even if the load conditions change unexpectedly.

Limit (compliance) feature prevents device damage

SMUs also possess a voltage and current limit (compliance) feature that allows the user to set limits and to protect devices from damage caused by excessive voltage or current. Although the SMU normally continues to function when it reaches the user-specified limit value, it can also be set to shutdown just like the over current protection (OCP) and over voltage protection (OVP) functions do on a power supply.

Accurate timing control of source and measurement resources

The integration of the source and measurement resources in an SMU allows much tighter synchronization than would be possible with separate instruments. Moreover, the B2900B/BL Series SMU provides very flexible triggering options that allow the measurements points to be defined independently from the sourced current or voltage waveform. On two channel units you can operate both channels in synchronization or independently, and under remote control you can trigger multiple units in unison using a group trigger signal.

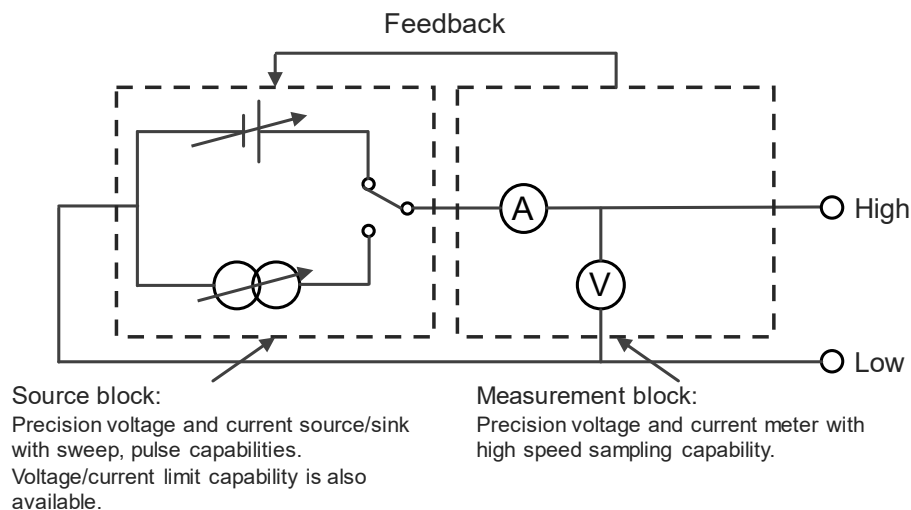

Innovative GUI and 4.3" Color LCD Display Facilitate Fast Bench-top Test, Debug and Characterization

The B2900B /BL Series SMU's front panel has many features that make interactive use fast and friendly. These include a 4.3" color LCD display, a USB2.0 memory I/O port, an assist key, an alphanumeric keypad and a rotary knob. The 4.3" color LCD display supports both graphical and numerical view modes and enables test setup and check test results quickly. The USB2.0 memory port supports easy data storing and porting. The Innovative graphical user interfaces, such as single view, dual view, graph view, roll view and zoom, improves usability and productivity of bench-top tests, debug and characterizations dramatically.

Single view:

Single view provides basic and advanced settings and display capabilities for the selected channel from the front panel of the instrument. No additional controller or software is required.

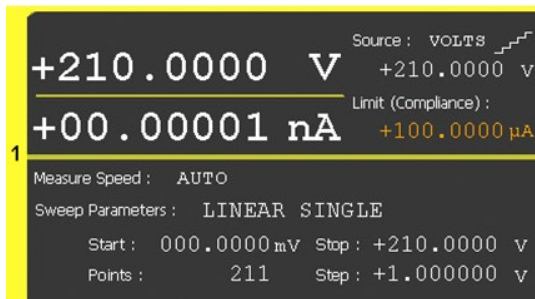

Dual view:

Dual view provides the basic settings and display capabilities for both channels 1 and 2. Up to 6. digits can be displayed in dual view mode. This mode is available only for the B2902B/B2912B.

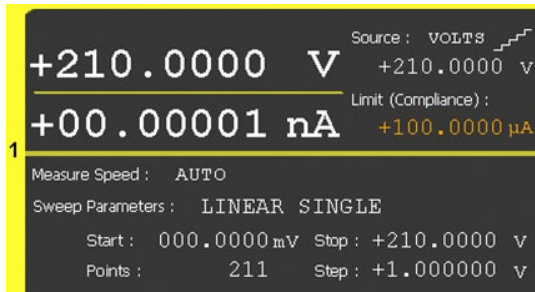

Graph view:

Graph View displays measurement results on XY graphs (such as I-V and I-t/V-t curves) on up to 2 channels. This is useful for quick evaluation of device characteristics, especially those obtained from sweep measurements.

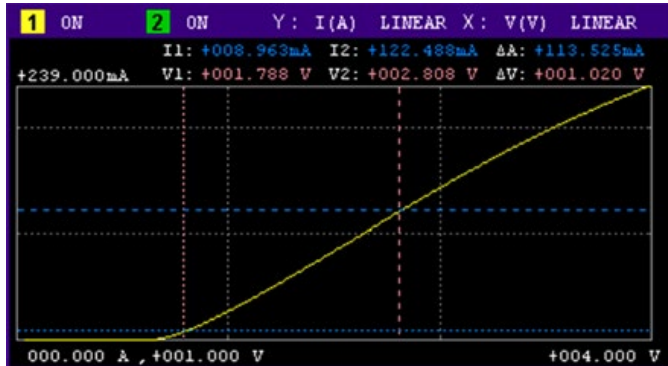

Roll view:

Roll view draws I-t or V-t curves similar to the curves drawn by a strip chart recorder. Up to 1000 acquired data points can be displayed and updated while the measurement is still in progress. Roll view's continuous measurement capability is especially useful for monitoring low frequency phenomena. Roll view is available only for the B2911B / B2912B.

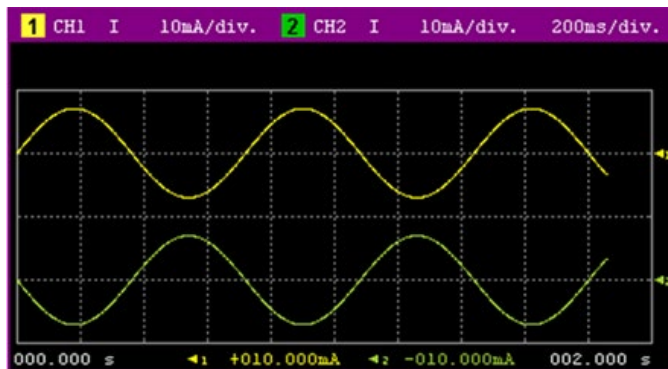

Graphical Web Interface

The Keysight B2900B/BL Series SMU has a built-in LXI compliant web server that allows any Java enabled web browser (such as Internet Explorer) to control it over the LAN. The graphical web interface supports all of the basic measurement functions such as spot measurements, sweep measurements and pulsed source measurements. Since no special software is required this feature is convenient for making quick measurements on the fly.

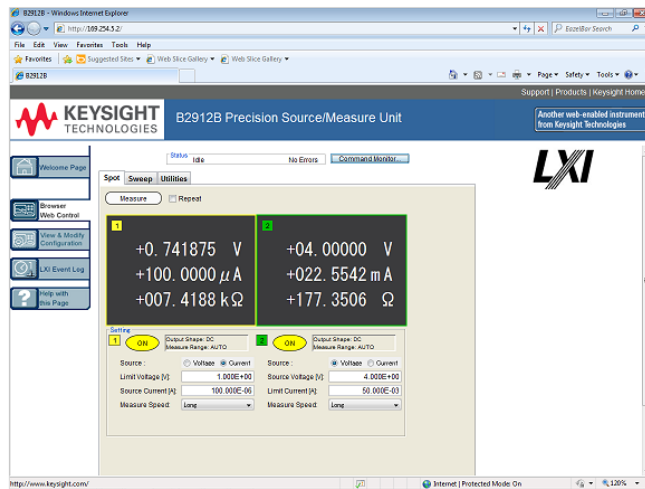

PW9251A PathWave IV Curve Software

The PW9251A PathWave IV Curve is a ready-made GUI software to perform a variety of synchronous current-voltage (IV) measurements without programming. Various analysis function on graphs and tables allow users to review test results immediately after the measurement. Export functions of graphs with markers and tables support efficient reporting. In addition, the test result files contains all the settings, allowing users to accurately review and repeat the test. The PW9251A PathWave IV Curve accelerates your research, development and design verification with increasing productivity, enabling more accurate and reliable data acquisition, and more efficient use of the equipment.

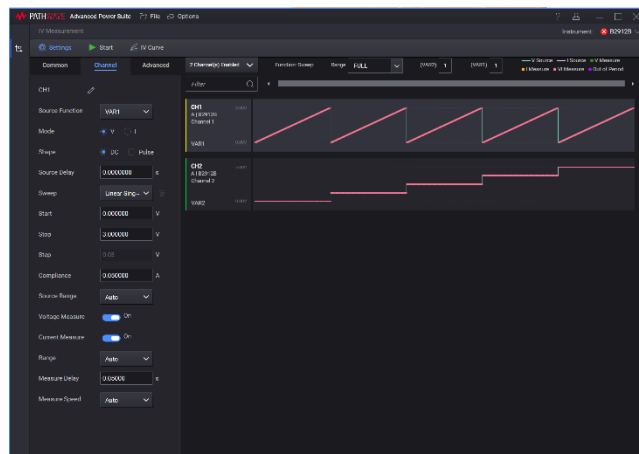

EasyEXPERTgroup+

Keysight EasyEXPERT group+ offers a robust IV parametric characterization solution for a wide range of devices and materials. It has an intuitive GUI (graphical user interface) that operates entirely with a mouse and keyboard, enabling you to simplify everyday characterization tasks such as test setup and execution, data analysis, data management/protection, etc. In addition, EasyEXPERT group+ facilitates the characterization of multi-terminal devices as it supports up to eight SMU channels (four 2-channel SMU units). The best part is that the B2900B/BL includes 15 licenses for the EasyExpert group +, and you can start using it right away at no extra cost.

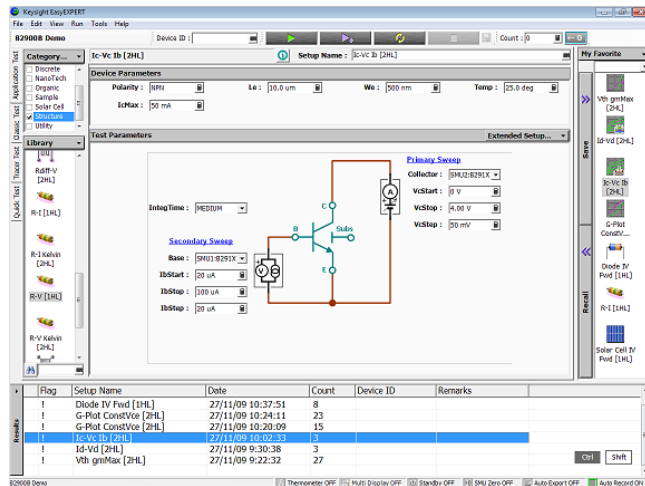

Available Accessories Facilitate Special Test Needs

Easy banana jack connectivity with various accessories

The B2900B/BL Series SMU uses convenient and low-cost banana jack terminals, which support a variety of cables, adaptors and accessories.

Banana to triaxial adaptor for low current measurement

Since banana jacks cannot support low current measurement (i.e. measurements of 1 nA and below), a banana jack to triaxial adapter is available to permit the use of high-performance triaxial cables. This makes it easy to connect to both triaxial-based test fixtures and wafer probers. Of course, both 2-wire and 4-wire triaxial adapters are available.

Test fixtures for testing packaged devices

The Keysight N1295A Device/Component Test Fixture provides a low-cost solution to quickly and easily test packaged devices and components. It has four triaxial inputs and supports voltage and current measurements of up to 42 V and 1 A.

For more advanced packaged testing needs, the Keysight 16442B test fixture provides more capabilities. It offers support for higher pin count devices, more flexible connectivity and an interlock feature for safely applying voltages greater than 42 V. Keysight can supply adapters to use the 16442B interlock with the B2900B/BL Series SMU's digital output.



Banana jack to triaxial adapters are available in both 2-wire and 4-wire versions.



The Keysight N1295A Device/Component Test Fixture provides a low-cost solution to quickly and easily test packaged devices and components.



Using the available accessories and furnished software you can create a low-cost PC-based component testing solution.



Comparison table by model

Model number	B2901BL	B2910BL	B2901B/B2902B	B2911B/B2912B
Number of channels	1	1	1 or 2	1 or 2
Output range				
Max. voltage	21 V	210 V	210 V	210 V
Max. current (DC)	1.5 A	1.5 A	3.03 A	3.03 A
Max. current (Pulse)	No	No	10.5 A	10.5 A
Source resolution				
Digit	5.5 digit	5.5 digit	5.5 digit	6.5 digit
Min. voltage	1 μ V	1 μ V	1 μ V	100 nV
Min. current	10 pA	100 fA	1 pA	10 fA
Lowest current range	1 μ A	10 nA	100 nA	10 nA
Measurement resolution				
Digit	6.5 digit	6.5 digit	6.5 digit	6.5 digit
Min. voltage	100 nV	100 nV	100 nV	100 nV
Min. current	1 pA	10 fA	100 fA	10 fA
Min. trigger interval	200 μ s	50 μ s	20 μ s	10 μ s
Max. trigger count	10,000	100,000	Infinite	Infinite
Max. data buffer size	10,000	100,000	100,000	100,000
Limit test	No	Yes	Yes	Yes
Fast transient mode	No	No	Yes	Yes
Easy file access	No	No	Yes	Yes
View mode				
Single view	Yes	Yes	Yes	Yes
Dual view	No	No	Yes (B2902B)	Yes (B2912B)
Graph view	Yes	Yes	Yes	Yes
Roll view	No	No	No	Yes

Specifications

Specification conditions

Temperature	23 °C \pm 5 °C
Humidity	30% to 80% RH
After 60 minutes warm-up	Ambient temperature change less than \pm 3 °C after self-calibration execution
Calibration period	1 year
Measurement speed	1 PLC (power line cycle)

Maximum voltage and current

	Max voltage	Max current
DC or pulsed ¹	210 V	0.105 A
	21 V	1.515 A ²
	6 V	3.03 A ²
Pulsed only ¹	200 V	1.515 A
	6 V	10.5 A

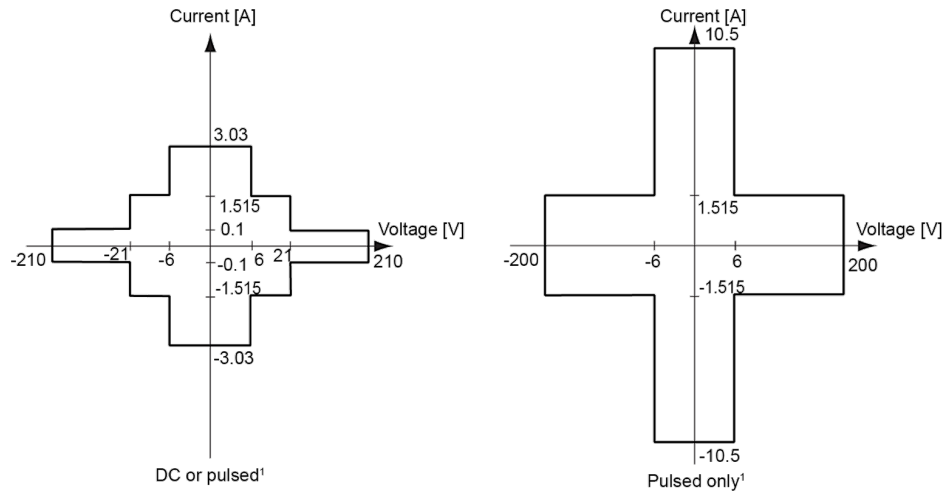

Maximum current limitation

Ch 1 voltage	Ch 2 voltage	Max total current limitation of Ch 1 and Ch 2
$\pm (0 \text{ V} < V \leq 6 \text{ V})$	$\pm (0 \text{ V} < V \leq 6 \text{ V})$	Ch 1 current + Ch 2 current $\leq 4 \text{ A}$
$\pm (0 \text{ V} < V \leq 6 \text{ V})$	$\pm (6 \text{ V} < V \leq 21 \text{ V})$	Ch 1 current + Ch 2 current $\times 1.6 \leq 4 \text{ A}$
$\pm (6 \text{ V} < V \leq 21 \text{ V})$	$\pm (0 \text{ V} < V \leq 6 \text{ V})$	Ch 1 current + Ch 2 current $\times 0.625 \leq 2.5 \text{ A}$
$\pm (6 \text{ V} < V \leq 21 \text{ V})$	$\pm (6 \text{ V} < V \leq 21 \text{ V})$	Ch 1 current + Ch 2 current $\leq 2.5 \text{ A}$

1. See "Maximum pulse width and duty cycle" in Pulse Source Supplemental Characteristics for applicable maximum voltage and current. Pulse mode is not available for B2901BL/B2910BL SMUs.
 2. Max current limitation: For 21 V/1.515 A and 6 V/3.03 A ranges, total max current is limited by the table below for using 2 channels. Max current is not limited for using 1 channel only.

Voltage source specifications

Range	Programming resolution				Accuracy (% reading + offset)	Noise (peak to peak) 0.1 Hz to 10 Hz ¹	Max voltage (over range)
	B2901BL	B2910BL	B2901B/ B2902B	B2911B/ B2912B			
±200 mV	1 µV	1 µV	1 µV	100 nV	± (0.015 % + 225 µV)	≤ 10 µV	±210 mV
±2 V	10 µV	10 µV	10 µV	1 µV	± (0.02 % + 350 µV)	≤ 20 µV	±2.1 V
±20 V	100 µV	100 µV	100 µV	10 µV	± (0.015 % + 5 mV)	≤ 200 µV	±21 V
±200 V ²	—	1 mV	1 mV	100 µV	± (0.015 % + 50 mV)	≤ 2 mV	±210 V

Current source specifications

Range	Programming resolution				Accuracy (% reading + offset)	Noise (peak to peak) 0.1 Hz to 10 Hz ¹	Max voltage (over range)
	B2901BL	B2910BL	B2901B/ B2902B	B2911B/ B2912B			
±10 nA ³	—	100 fA	—	10 fA	± (0.10 % + 50 pA)	≤ 1 pA	±10.5 nA
±100 nA ⁴	—	1 pA	1 pA	100 fA	± (0.06 % + 100 pA)	≤ 2 pA	±105 nA
±1 µA	10 pA	10 pA	10 pA	1 pA	± (0.025 % + 500 pA)	≤ 25 pA	±1.05 µA
±10 µA	100 pA	100 pA	100 pA	10 pA	± (0.025 % + 1.5 nA)	≤ 60 pA	±10.5 µA
±100 µA	1 nA	1 nA	1 nA	100 pA	± (0.02 % + 25 nA)	≤ 2 nA	±105 µA
±1 mA	10 nA	10 nA	10 nA	1 nA	± (0.02 % + 200 nA)	≤ 6 nA	±1.05 mA
±10 mA	100 nA	100 nA	100 nA	10 nA	± (0.02 % + 2.5 µA)	≤ 200 nA	±10.5 mA
±100 mA	1 µA	1 µA	1 µA	100 nA	± (0.02 % + 20 µA)	≤ 600 nA	±105 mA
±1 A	10 µA	10 µA	10 µA	1 µA	± (0.03 % + 1.5 mA)	≤ 70 µA	±1.05 A
±1.5 A	10 µA	10 µA	10 µA	1 µA	± (0.05 % + 3.5 mA)	≤ 100 µA	±1.515 A
±3 A ⁵	—	—	100 µA	10 µA	± (0.4 % + 7 mA)	≤ 120 µA	±3.03 A
±10 A ^{4, 5, 6}	—	—	100 µA	10 µA	± (0.4 % + 25 mA) ⁷	—	±10.5 A

1. Supplemental characteristics.
2. 200 V range is not available for B2901BL.
3. 10 nA range is not available for B2901BL/B2901B/B2902B.
4. 100 nA range is not available for B2901BL.
5. 3A, 10 A ranges are not available for B2901BL/B2910BL.
6. 10 A range is available only for pulse mode, not available for DC mode.
7. Measurement speed: 0.01 PLC.

Source supplemental characteristics

Temperature coefficient (0 to 18 °C and 28 to 50 °C)	$\pm (0.1 \times \text{accuracy})/^{\circ}\text{C}$	
Max output power and source/sink limits	B2901BL	31.8 W $\pm 6 \text{ V @ } \pm 1.515 \text{ A}$, $\pm 21 \text{ V @ } \pm 1.515 \text{ A}$, four quadrant source or sink operation
	B2910BL	31.8 W $\pm 6 \text{ V @ } \pm 1.515 \text{ A}$, $\pm 21 \text{ V @ } \pm 1.515 \text{ A}$, $\pm 210 \text{ V @ } \pm 105 \text{ mA}$, four quadrant source or sink operation
	Other models	31.8 W $\pm 6 \text{ V @ } \pm 3.03 \text{ A}$, $\pm 21 \text{ V @ } \pm 1.515 \text{ A}$, $\pm 210 \text{ V @ } \pm 105 \text{ mA}$, four quadrant source or sink operation
Current limit/compliance	Accuracy is same as current source. Minimum value is 1 % of range, or 1 nA in 10 nA range.	
Voltage limit/compliance	Accuracy is same as voltage source. Minimum value is 1 % of range, or 20 mV in 200 mV range	
Over range	101 % of source range for 1.5 A and 3 A ranges. 105 % of source range other than 1.5 A and 3 A ranges. No over range for 200 V range with current exceeding 105 mA pulse only condition.	
Over temperature protection	Output turns off then resets at over temperature sensed internally	
Voltage Output Settling time	200 mV, 2 V ranges	< 50 μs
	20 V range	< 110 μs
	200 V range	< 700 μs
Slew rate	$\leq 0.36 \text{ V}/\mu\text{s}$, 20 V and 10 mA ranges, 10 M Ω load resistance	
	Time required to reach within 0.1 % (0.3 % for 3 A range) of final value at short condition. Step is 10 % to 90 % range	
Current output settling time	10 nA, 100 nA ranges	< 10 ms
	1 μA range	< 500 μs
	10 μA , 100 μA ranges	< 250 μs
	1 mA to 3 A ranges	< 80 μs
Noise 10 Hz to 20 MHz (V source)	3 mVrms, 20 V range	
V source overshoot	< $\pm (0.1 \% + 10 \text{ mV})$. Step is 10 % to 90 % range, resistive load	
I source overshoot	< $\pm 0.1 \%$ (< $\pm 0.3 \%$ for 3 A range). Step is 10 % to 90 % range, resistive load	
Voltage source range change overshoot	$\leq 250 \text{ mV}$. 100 k Ω load, 20 MHz bandwidth	
Current source range change overshoot	$\leq 250 \text{ mV}/R$ load, 20 MHz bandwidth	

Pulse source supplemental characteristics

Minimum programmable pulse width	50 μ s
Pulse width programming resolution	1 μ s
Pulse width definition	The time from 10 % leading to 90 % trailing edge as follows

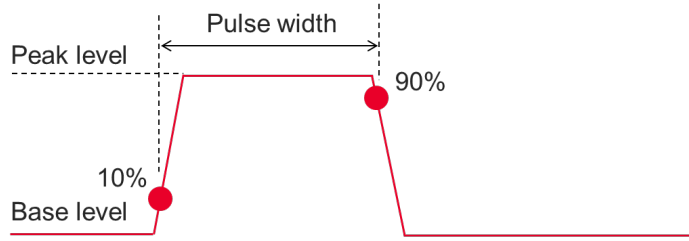

	Pulsed					DC	
	Max voltage	Max peak current	Max base current	Pulse width	Max duty cycle	Max voltage	Max current
DC or pulsed	210 V	0.105 A	0.105 A	50 μ s to 99999.9 s	99.9999 %	210 V	0.105 A
	21 V	1.515 A ¹	1.515 A ¹	50 μ s to 99999.9 s	99.9999 %	21 V	1.515 A ¹
	6 V	3.03 A ¹	3.03 A ¹	50 μ s to 99999.9 s	99.9999 %	6 V	3.03 A ¹
Pulsed only	200 V	1.515 A	50 mA	50 μ s to 2.5 ms	2.5 %		
	180 V	1.05 A	50 mA	50 μ s to 10 ms	2.5 %		
	6 V	5.25 A	0.1 A	50 μ s to 3 ms	3.0 %		
	6 V	10.5 A	0.5 A	50 μ s to 1 ms	2.5 %		

Minimum pulse width at the given voltage, current and settling conditions

Source value	Limit value	Load	Source settling (% of range)	Min pulse width
200 V	1.5 A	200 Ω	0.1%	1 ms
6 V	10.5 A	0.6 Ω	0.1%	0.2 ms
1.5 A	200 V	65 Ω	0.1%	2.5 ms
10.5 A	6 V	0.5 Ω	0.1%	0.2 ms
10.5 A ²	6 V ²	0.1 Ω ²	0.1% ²	0.1 ms ²

1. Max current limitation: For 21 V/1.515 A and 6 V/3.03 A ranges, total max current is limited by the table in page 13 for using 2 channels. Max current is not limited for using 1 channel only.
 2. Transient speed mode is set to FAST.

Voltage measurement specifications

Range	Measurement resolution				Accuracy (% reading + offset)
	B2901BL	B2910BL	B2901B/B2902B	B2911B/B2912B	
±200 mV	100 nV	100 nV	100 nV	100 nV	± (0.015 % + 225 µV)
±2 V	1 µV	1 µV	1 µV	1 µV	± (0.02 % + 350 µV)
±20 V	10 µV	10 µV	10 µV	10 µV	± (0.015 % + 5 mV)
±200 V ¹	—	100 µV	100 µV	100 µV	± (0.015 % + 50 mV)

Current measurement specifications

Range	Measurement resolution				Accuracy (% reading + offset)
	B2901BL	B2910BL	B2901B/B2902B	B2911B/B2912B	
±10 nA ²	—	10 fA	—	10 fA	± (0.10 % + 50 pA)
±100 nA ³	—	100 fA	100 fA	100 fA	± (0.06 % + 100 pA)
±1 µA	1 pA	1 pA	1 pA	1 pA	± (0.025 % + 500 pA)
±10 µA	10 pA	10 pA	10 pA	10 pA	± (0.025 % + 1.5 nA)
±100 µA	100 pA	100 pA	100 pA	100 pA	± (0.02 % + 25 nA)
±1 mA	1 nA	1 nA	1 nA	1 nA	± (0.02 % + 200 nA)
±10 mA	10 nA	10 nA	10 nA	10 nA	± (0.02 % + 2.5 µA)
±100 mA	100 nA	100 nA	100 nA	100 nA	± (0.02 % + 20 µA)
±1 A	1 µA	1 µA	1 µA	1 µA	± (0.03 % + 1.5 mA)
±1.5 A	1 µA	1 µA	1 µA	1 µA	± (0.05 % + 3.5 mA)
±3 A ⁴	—	—	10 µA	10 µA	± (0.4 % + 7 mA)
±10 A ^{3, 5}	—	—	10 µA	10 µA	± (0.4 % + 25 mA) ⁶

Measurement supplemental characteristics

Temperature coefficient (0 to 18 °C and 28 to 50 °C)	± (0.1 x accuracy)/°C
Over range	102 % of measurement range for 1.5 A and 3 A ranges 106 % of measurement range other than 1.5 A and 3 A ranges
Voltage measurement range change overshoot	< 250 mV, 100 kΩ load, 20 MHz bandwidth
Current measurement range change overshoot	< 250 mV/R load, 20 MHz bandwidth
Derating accuracy for measurement speed less than 1 PLC	Add % of range using the following table for measurement with PLC < 1

1. 200 V range is not available for B2901BL.
2. 10 nA range is not available for B2901BL/B2901B/B2902B.
3. 100 nA range is not available for B2901BL.
4. 3 A, 10 A ranges are not available for B2901BL/B2910BL.
5. 10 A range is available only for pulse mode, not available for DC mode.
6. Measurement speed: 0.01 PLC.

Derating accuracy with PLC setting < 1 PLC

	Voltage range			Current range		
	0.2 V	2 V to 200 V	10 nA	100 nA	1 μ A to 100 mA	1 A to 3 A
0.1 PLC	0.01%	0.01%	0.1%	0.01%	0.01%	0.01%
0.01 PLC	0.05%	0.02%	1%	0.1%	0.05%	0.02%
0.001 PLC	0.5%	0.2%	5%	1%	0.5%	0.2%

Timer and triggering specification

Timer	Time stamp	TIMER value automatically saved when each measurement is triggered
	Trigger timing resolution	1 μ s to 100 ms
	Accuracy	\pm 50 ppm
	Arm/trigger delay	0 μ s to 100,000 s
	Arm/trigger interval	B2901BL: 200 μ s to 100,000 s
		B2910BL: 50 μ s to 100,000 s
		B2901B/B2902B: 20 μ s to 100,000 s B2911B/B2912B: 10 μ s to 100,000 s
Arm/trigger event	B2901BL: 1 to 10,000 Other models: 1 to 100,000	
Triggering ¹	Digital I/O Trigger IN to Trigger OUT	\leq 5 μ s
	Digital I/O Trigger IN to source change	\leq 5 μ s
	LXI Trigger IN to source change	Minimum 100 μ s, Typical 200 μ s, Maximum unknown
	LXI Trigger IN to measurement	Minimum 100 μ s, Typical 200 μ s, Maximum unknown
	Internal event to external LXI trigger output	Minimum 100 μ s, Typical 200 μ s, Maximum unknown
	LXI event send/receive latency	Unknown
	Minimum trigger interval	10 μ s

1. Supplemental characteristics.

Other supplemental characteristics

Output characteristics

Sensing modes	2-wire or 4-wire (remote-sensing) connections
Low terminal connection	Chassis grounded or floating
Output connectors	Banana jack. Triaxial connections are recommended for sourcing and measuring less than 1 nA. A banana jack to triaxial adapter is available for low current measurement.
Output location	Channel 1 at front, and channel 2 at rear
Maximum load	Normal mode: 0.01 μ F High capacitance mode: 50 μ F
DC floating voltage	Max \pm 250 V DC between low force and chassis ground
Guard offset voltage (V source)	< 4 mV
Remote sense operation range	Max voltage between High Force and High Sense = 3 V Max voltage between Low Force and Low Sense = 3 V
Common mode isolation	> 1 G Ω , < 4500 pF
Maximum sense lead resistance	1 k Ω for rated accuracy
Sense input impedance	> 10 G Ω

High capacitance mode

The high capacitance mode permits the measurement of devices with capacitances greater than the normal mode maximum load value of 0.01 μ F. In high capacitance mode the maximum allowed value of the load capacitance is 50 μ F.

Voltage output settling time		Time required to reach within 0.1 % of final value with 4.7 μ F capacitive load on a fixed range at specified current range and limit value	
		200 mV, 2 V ranges	600 μ s, at 1 A limit
		20 V range	1.5 ms, at 1 A limit
		200 V range	20 ms, at 100 mA limit
Current measurement settling time		Time required to reach within 0.1 % of final value after voltage source is stabilized on fixed range. Vout is 5 V unless noted.	
		1 μ A range	230 ms
		10 μ A, 100 μ A ranges	23 ms
		1 mA, 10 mA ranges	0.23 ms
		100 mA to 3 A ranges	100 μ s
Mode change delay	Delay into high cap mode	1 μ A range	230 ms
		10 μ A, 100 μ A ranges	23 ms
		1 mA to 3 A ranges	1 ms
	Delay out of high cap mode	All ranges	10 ms
Noise 10 Hz to 20 MHz (20 V range)		4.5 mVrms	
Voltage source range change overshoot (20 V range or below)		< 250 mV, 20 MHz bandwidth	
High capacitance mode working conditions	V/I mode	Voltage source mode only	
	Range	Current measurement range is limited to fixed range only. 10 nA and 100 nA ranges are not available.	
Current limit		\geq 1 μ A	

Resistance measurement

Resistance measurement can be performed under either auto or manual test conditions. Auto resistance measurement is performed in current source and voltage measurement mode. The total auto resistance measurement error is shown in the table below. The total error of a manual resistance measurement can be calculated using the voltage and current accuracy information as shown below.

Source I mode, manual ohm measurement (4-wire)	Total error = $V_{meas}/I_{src} = R$ reading x (gain error % of V range + gain error % of I range + offset error of I range/ I_{src} value %) + (offset error of V range/ I_{src} value)
Source V mode, manual ohm measurement (4-wire)	Total error = $V_{src}/I_{meas} = 1/[1/R$ reading x (gain error % of I range + gain error % of V range + offset error of V range/ V_{src} value %) + (offset error of I range/ V_{src} value)]
Measurement speed	1 PLC
Applicable for temperature	23 °C ±5 °C
Example of total error calculation	-I source value = 1 mA at 1 mA range V measure range = 2 V range Total error (% reading + offset) = (0.02 % + 0.02 % + 200 nA/1 mA) + (350 μV/1 mA) = 0.06 % + 0.35 Ω

Typical performance of auto resistance measurement (4-wire), 2 V range

Range	Resolution	Test current	Current range	Total error (% reading + offset)
2 Ω	1 μΩ	1 A	1 A	0.2% + 0.00035 Ω
20 Ω	10 μΩ	100 mA	100 mA	0.06% + 0.0035 Ω
200 Ω	100 μΩ	10 mA	10 mA	0.065% + 0.035 Ω
2 kΩ	1 mΩ	1 mA	1 mA	0.06% + 0.35 Ω
20 kΩ	10 mΩ	100 μA	100 μA	0.065% + 3.5 Ω
200 kΩ	100 mΩ	10 μA	10 μA	0.06% + 35 Ω
2 MΩ	1 Ω	1 μA	1 μA	0.095% + 350 Ω
20 MΩ ¹	10 Ω	100 nA	100 nA	0.18% + 3.5 kΩ
200 MΩ ¹	100 Ω	10 nA	100 nA	1.08% + 35 kΩ

System speeds: Maximum sweep operation reading rates (reading/second) for 50 Hz

Measure speed	Measure to memory	Measure to GPIB	Source measure to memory	Source measure to GPIB
< 0.001 PLC	20000	12500	19500	12500
0.01 PLC	4500	3950	4500	3950
0.1 PLC	500	490	500	490
1 PLC	49	49	49	49

Operation reading rate varies by number of sweep steps. Number of sweep steps is specified.

1. 20 MΩ, 200 MΩ ranges are not available for B2901BL.

Environmental specifications

Environment		For use in indoor facilities
Operating		0 °C to +55 °C, 30 % to 80 % non-condensing
Storage		-30 °C to 70 °C, 10 % to 90 % non-condensing
Altitude		Operating: 0 m to 2000 m, Storage: 0 m to 4600 m
Power supply		90 V to 264 V, 47 Hz to 63 Hz, 250 VA maximum
Overvoltage category		II
Pollution degree		2
EMC		IEC61326-1/EN61326-1, AS/NZS CISPR 11, KC: RRA Notification amending Radio Waves Act Article 58-2
Safety		IEC61010-1/EN61010-1, CAN/CSA-C22.2 No. 61010-1, C/US
Certifications		CE, cCSAus, RCM, KC
Warm-up		1 hour
Dimensions	Case	88 mm (2U) x 213 mm (half width) x 450 mm
	Working	180 mm x 260 mm x 480 mm (with handle and feet)
Weight	Net	6.0 kg (B2901BL, B2910BL, B2901B, B2911B), 7.4 kg (B2902B, B2912B)
	Shipping	9.5 kg (B2901BL, B2910BL, B2901B, B2911B), 11.0 kg (B2902B, B2912B)

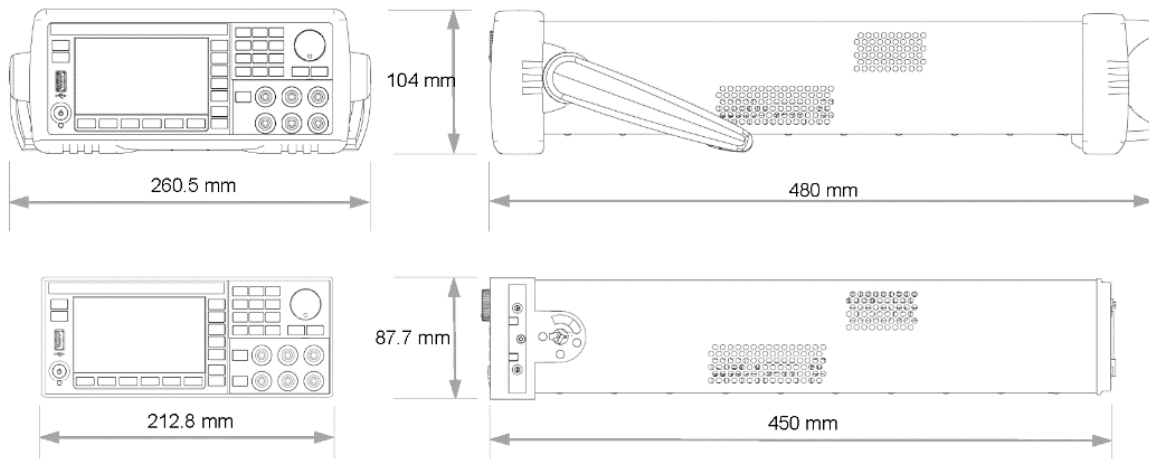

Front panel operation

Front panel interface	4.3" TFT color display (480 x 272, with LED backlight) with keypads and rotary knob
View mode	Single view, Dual view, Graph view and Roll view
Hard keys	Single Trigger and Auto Trigger control, 10-key, Rotary Knob and Cursors, Channel on/off, View, Cancel/Local
Softkeys	Function, System and Input Assist Keys
Indicators	Channel (measurement) status, System status

Source/measurement capabilities

Sweep measurement

Number of steps	B2901BL: 1 to 10,000
	Other models: 1 to 100,000
Sweep mode	Linear, logarithmic (log) or list
Sweep direction	Single or double
Type	DC, or pulse
Min programmable value to create list sweep waveform	B2901BL: Min 200 μ s with 1 μ s resolution
	B2910BL: Min 50 μ s with 1 μ s resolution
	B2901B/B2902B: Min 20 μ s with 1 μ s resolution
	B2911B/B2912B: Min 10 μ s with 1 μ s resolution

Digitizing/sampling measurement

Min trigger interval (max speed of measurement)	B2901BL: 200 μ s (5,000 points/s)
	B2910BL: 50 μ s (20,000 points/s)
	B2901B/B2902B: 20 μ s (50,000 points/s)
	B2911B/B2912B: 10 μ s (100,000 points/s)

Data buffers

Max buffer size	B2901BL: 10,000 points/channel
	Other models: 100,000 points/channel

Input/output connectivity

GP-IB	IEEE-488.2	
Ethernet	100BASE-T/10BASE-T	
USB	USB 2.0 host controller (front)	
	USB 2.0 device interface (rear)	
Digital I/O	Connector type	25-pin female D
	Input/output pins	14 open drain I/O bits
	Absolute max input voltage	5.25 V
	Absolute min input voltage	-0.25 V
	Max logic L input voltage	0.8 V
	Min logic H input voltage	2.0 V
	Max source current	1 mA @ Vout = 0 V
	Max sink current	50 mA @ Vout = 5 V
	5 V power supply pin	Limited to 500 mA, solid state fuse protected
	Safety interlock pin	One active high pin and one active low pin. Activation of both pins enables output voltage > 42 V
	Maximum number of simultaneously triggered units (using Digital I/O) ¹	8

1. Supplemental characteristics.

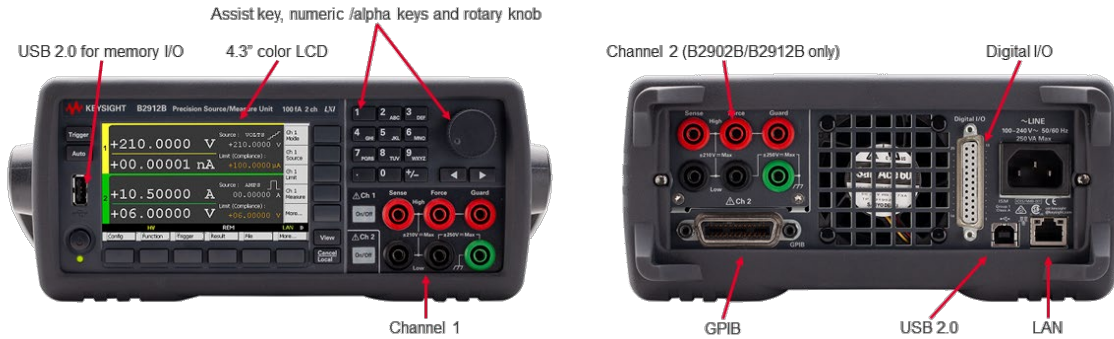

Program, software and drivers

Programming	SCPI
Program memory	100 kB (2500 lines typical)
LXI compliance	LXI Core 2011
Software available	EasyEXPERT group+, PW9251A PathWave IV Curve Software, Graphical Web Interface, PathWave BenchVue
Drivers available	IVI-C, IVI-COM drivers, LabVIEW drivers

Software prerequisites

EasyEXPERTgroup+	Operating system	Microsoft Windows 8.1 Professional or later (32bit/64bit), Microsoft Windows 10 Pro or later (32bit/64bit)
	Supporting language	English (US)
	.NET Framework	Microsoft .NET, Framework 3.5 SP1
	IO Libraries	Keysight IO Libraries Suite 17.1 update 1 or later (for the Online execution mode)
	Memory	2 GB memory
	Display	XGA 1024 x 768 (SXGA 1280 x 1024 recommended)
	HDD	Installation: 1 GB free disk space on the C drive, Test setup/result data storage: Free disk space more than 30GB is recommended
PW9251A PathWave IV Curve Software	Recommended GPIB I/F	Keysight 82350B/C (PCI) ¹ , 82351B (PCIe) ¹ 82357A (USB) ^{2, 3} 82357B (USB) ^{2, 3} National Instrument: GPIB-USB-HS (USB) ^{1, 2}
	Operating system	Windows 10 (64 bit),
	Processor	Intel Core i5 (or equivalent)
	RAM	8 GB
	Storage Drive	900 MB free space for Windows
	Display resolution	1920 x 1080 minimum
PathWave BenchVue	Interfaces	USB, GPIB, LAN
	Operating system	Windows 10 32-bit and 64-bit (Professional, Enterprise, Education, Home versions) Windows 8 32-bit and 64-bit (Professional, Enterprise, Core)
	HDD	Processor: 1 GHz or faster (2 GHz or greater recommended) RAM: 1 GB (32-bit) or 2 GB (64-bit) (3 GB or greater recommended)
	Display resolution	1024 x 768 minimum for single instrument view (higher resolutions are recommended for multiple instrument view)
Interfaces	USB, GPIB, LAN, RS-232	

1. A PCI or PCIe card is highly recommended because of stability and speed.
2. USB GPIB interfaces might cause serial poll error intermittently due to the intrinsic communication scheme differences. It is reported that using an even GPIB address sometimes significantly decreases the chance of the error. The NI GPIB -USB-HS is recommended for stability, and the Keysight 82357x is recommended for speed.
3. EasyEXPERT software prohibits to set the odd GPIB address to prevent the issue above.

Furnished Accessories

Power cable, USB cable, Quick Reference (English)

Ordering Information

Model number

B2901BL	Precision source/measure unit, 1 ch, 1 pA resolution, 21 V, 1.5 A
B2910BL	Precision source/measure unit, 1 ch, 10 fA resolution, 210 V, 1.5 A
B2901B	Precision source/measure unit, 1 ch, 100 fA, 210 V, 3 A DC/10.5 A pulse
B2902B	Precision source/measure unit, 2 ch, 100 fA, 210 V, 3 A DC/10.5 A pulse
B2911B	Precision source/measure unit, 1 ch, 10 fA, 210 V, 3 A DC/10.5 A pulse
B2912B	Precision source/measure unit, 2 ch, 10 fA, 210 V, 3 A DC/10.5 A pulse

Options

1A7	Calibration + Uncertainties + Guardbanding (not accredited)
A6J	ANSI Z540-1-1994 calibration
UK6	Commercial calibration certificate with test data

Accessories

N1297A	Banana - Triax adapter for 2-wire (non-Kelvin) connection
N1297B	Banana - Triax adapter for 4-wire (Kelvin) connection
N1294A-011	Interlock cable for 16442B (1.5 m)
N1294A-012	Interlock cable for 16442B (3.0 m)
N1294A-031	GPIO-BNC trigger adapter
N1294A-032	Digital I/O trigger cable for multiple unit control
16494A-001	Low leakage triax cable (1.5 m)
16494A-002	Low leakage triax cable (3.0 m)
16494A-005	Low leakage triax cable (4.0 m)
1CM124A	Rack mount flange kit

Upgrade kit

B2901BLU	B2901BL Software Upgrade Package, Extension Support and Subscription
B2910BLU	B2910BL Software Upgrade Package, Extension Support and Subscription
B2901BU	B2901B Software Upgrade Package, Extension Support and Subscription
B2902BU	B2902B Software Upgrade Package, Extension Support and Subscription
B2911BU	B2911B Software Upgrade Package, Extension Support and Subscription
B2912BU	B2912B Software Upgrade Package, Extension Support and Subscription

Keysight enables innovators to push the boundaries of engineering by quickly solving design, emulation, and test challenges to create the best product experiences. Start your innovation journey at www.keysight.com.